

# ANCHOR PENDANT BUOY

## DONUT MODULAR TYPE – MODEL DU-2

Product Code : AC-3310

We designed the buoy to withstand the offshore standard and requirement, rigorous conditions.

Type	Buoyancy (kg)	Modules	Diameter D (mm)	Length L (mm)	Weight in Air (kg)
DU-2-8T	8000	4T X 2	2300	2650	840
DU-2-12T	12000	6T X 2	2300	3550	1240
DU-2-16T	16000	4T X 4	2300	5150	1520
DU-2-20T	20000	6T X 2, 4T X 2	2300	6050	1960
DU-2-24T	24000	12T X 2	3200	3600	2400

### DU-2

1. Flotation : PE Close Cell Foam. Ensure the buoy will not absorb water even if the skin is punctured.
2. Skin : Encapsulated with Spray Polyurea – Elastomer.
3. The resilient material makes the buoys self fendering with a high impact absorption capacity.
4. Steel Frame is blast cleaned and spray thermal galvanized and coat with painted.
5. Buoyancy Modules are added or removed from steel column to comply with nett buoyancy requirement.

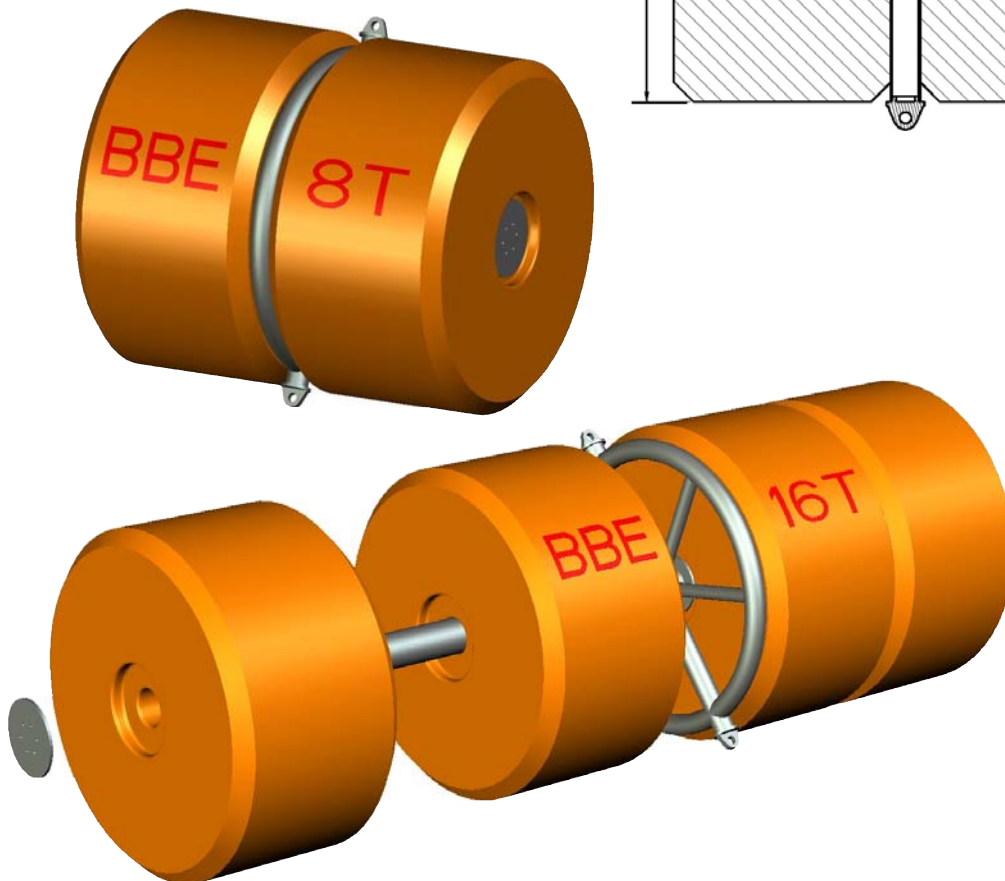
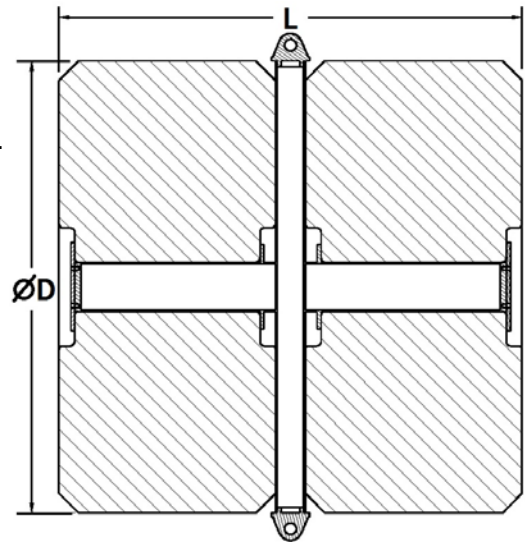

# ANCHOR PENDANT BUOY

## DONUT MODULAR TYPE – MODEL DU-2









The buoyancy modules are constructed by extruded foam – built up as flat sheets or as spirally wound cylinders using heat and pressure to create structured. Surface spray with polyurea elastomer in orange or yellow colour.

Options :

- Internal Radar Reflectors.
- Reflective Tape.
- Navigation Light.
- Other Colour as request by client.
- Specific Dimension as client request.

**Connection Options :**

					
Chain Through Plate	Chain Through Pin	Pad Eye	Round Eye	Crucifix	Swivel